

# Unrepeated DPSK transmission over 360 km SMF-28 fibre using URFL based amplification

P. Rosa,<sup>1\*</sup> J-D Ania-Castañón<sup>2</sup> and P. Harper<sup>1</sup>

<sup>1</sup>Aston Institute of Photonic Technologies, Aston University, B4 7ET, UK

<sup>2</sup>Instituto de Óptica, IO-CSIC, CSIC, Madrid, 28006, Spain

\*p.g.rosa@icloud.com

**Abstract:** Unrepeated 42.7 Gb/s per channel RZ-DPSK transmission over standard SMF-28 fibre with novel URFL based amplification using fibre Bragg gratings is investigated. OSNR and gain performance are studied experimentally and through simulations. Error free transmission for 16 channels across the full C-band with direct detection was experimentally demonstrated for 280 km span length, as well as 6-channel transmission at 340 km and single-channel transmission up to 360 km (75 dB) without employing ROPA or specialty fibres.

© 2014 Optical Society of America

**OCIS codes:** (060.4510) Optical communications.

---

## References and links

1. C. Lin and R. H. Stolen, "Backward Raman amplification and pulse steepening in silica fibers," *Appl. Phys. Lett.* **29**, 428–431 (1976).
  2. J. Bromage, "Raman amplification for fiber communications systems," *J. Lightwave Tech.* **22**, 79–93 (2004).
  3. M. Vasilyev, "Raman-assisted transmission: toward ideal distributed amplification," in *Proc. OFC'03* **WB1**, 303–305 (2003).
  4. J. D. Ania-Castañón, "Quasi-lossless transmission using second-order Raman amplification and fibre Bragg gratings," *Opt. Express* **12**, 4372–4377 (2004).
  5. J. D. Ania-Castañón, V. Karalekas, P. Harper, and S. K. Turitsyn, "Simultaneous spatial and spectral transparency in ultralong fiber lasers," *Phys. Rev. Lett.* **101**, 123903 (2008).
  6. J.D. Ania-Castañón, V. Karalekas, J. Perez-Gonzalez, P. Harper, X. Chen, and L. Zhang, "Signal power excursion and pump efficiency in quasi-lossless ultra-long Raman laser links," in *Proc. ECOC'06*, (2006).
  7. V. E. Perlin and H. G. Winful, "On trade-off between noise and nonlinearity in WDM systems with distributed Raman amplification," in *Proc. OFC'02*, **WB1**, (2002).
  8. M. Alcon-Camas, A.E. El-Taher, J-D. Ania-Castañón, and P. Harper, "Gain bandwidth optimisation and enhancement in ultra-long Raman fibre laser based amplifiers," in *Proc. ECOC'10*, **P1.17**, (2010).
  9. S. Popov, S. Sergeev, and A. T. Friberg, "The impact of pump polarization on the polarization dependence of the Raman gain due to the breaking of a fibre's circular symmetry," *J. Opt. A: Pure Appl. Opt.* **6**, (2004).
  10. J. C. Bouteiller, K. Brar, and C. Headley, "Quasi-constant signal power transmission," in *Proc. ECOC'02* **3**, (2002).
  11. E. Desurvire, *Erbium-doped fiber amplifiers*. (New York: Wiley, 1994).
  12. P. A. Humblet and M. Azizoglu, "On the bit error rate of lightwave systems with optical amplifiers," *J. Lightwave Tech.* **11**, 1576–1582 (1991).
  13. S. D. Personick, "Receiver design for digital fiber optic communication systems II," *Bell Syst. Tech. J.* **6**, 875–886 (1973).
  14. A. Klekamp, R. Dischler and W. Idler, "DWDM and single channel fibre nonlinear thresholds for 43 Gb/s ASK and DPSK formats over various fibre types," in *Proc. OFC'06*, **OFD5**, (2006).
  15. R. H. Stolen and E. P. Ippen, "Raman gain in glass optical waveguides," *Appl. Phys. Lett.* **22**, 276–278 (1973).
  16. R. H. Stolen, Clinton Lee, and R. K. Jain, "Development of the stimulated Raman spectrum in single-mode silica fibers," *J. Opt. Soc. Am. B* **5**, 652–657 (1984).
-

## 1. Introduction

Stimulated Raman scattering (SRS) is a non-linear process that can provide an optical gain downshifted in frequency and may be used in optical amplification [1]. In long-haul and unrepeated links, distributed Raman amplification prevents signal decay by distributing the gain across the transmission span [2,3]. In particular, second-cascade pumping can reduce variations of the effective gain-loss coefficient along the span [4]. This leads to a better noise figure and improves OSNR which is crucial in long-haul transmissions systems with advanced modulation formats.

Ultra-long Raman fibre laser (URFL) amplification [4–6], relying on a scheme that uses fibre Bragg grating (FBG) to form an ultra-long laser cavity in the transmission fibre, allows to achieve second-cascade pumping of the signal with a single pump wavelength, reducing signal power excursion [6]. This can be used to realise a quasi-lossless span, approximating the optimal case for transmission performance [7] and offers an excellent balance between nonlinear and noise impairments. Contrary to conventional second-cascade Raman amplification, in URFL the spectral gain profile can be modified, and indeed enhanced, without the need from additional pumping sources, just by selecting appropriate FBGs [6, 8].

In this paper, we investigate OSNR, on-off gain and RZ-DPSK transmission performance in unrepeated spans up to 360 km using cavity URFL-based amplification [4].

## 2. OSNR and gain profile with URFL based amplification

The schematic diagram for OSNR and on-off gain measurements is shown in Fig. 1. Continuous wave distributed feedback (CW-DFB) laser diodes (LDs) are multiplexed using a passive athermal arrayed wave-guide grating (AWG) multiplexer to form 16 even channels spread across C-band. In order to keep DFBs noise figure fixed, launch power into the span was adjusted with a VOA. The output signal is multiplexed through a 1366/1550 nm coupler with the Raman pump at 1366 nm. High reflectivity ( $\sim 95\%$ ) FBGs with a bandwidth of 0.5 nm, centred at 1458 nm and 0.5 dB loss were spliced at each end of the transmission span to reflect the Stokes-shifted signal generated by the primary pump. The polarisation dependence of the Raman gain [9] was minimised by using a highly de-polarised fibre laser for the 1366 nm Raman pump. The fibre used in experiments was a standard SMF-28.

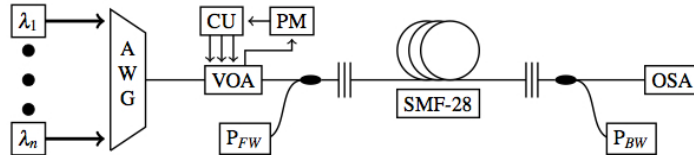

Fig. 1. Experimental setup for OSNR and On-Off gain measurement in URFL based amplifier with high reflectivity FBGs. Input power into the span is controlled by VOA connected to control unit (CU) and power meter (PM). FW: forward, BW: backward Raman pump.

### 2.1. Optimization

Two sets of FBGs (Fig. 2) centred at 1448 nm (black) and 1458 nm (red) were tested with 320 km span. The peak at 1366 nm is generated by the Raman source pump. The broadband gain of distributed Raman amplification with its peak down-shifted by approximately 13 THz is visible in 1450 nm region. The cavity created by pair of gratings generates virtual secondary pump which provides amplification to the signal at 1550 nm region [4]. FBGs at 1448 nm provides better gain distribution across C-band grid used in the experiment therefore has been chosen.

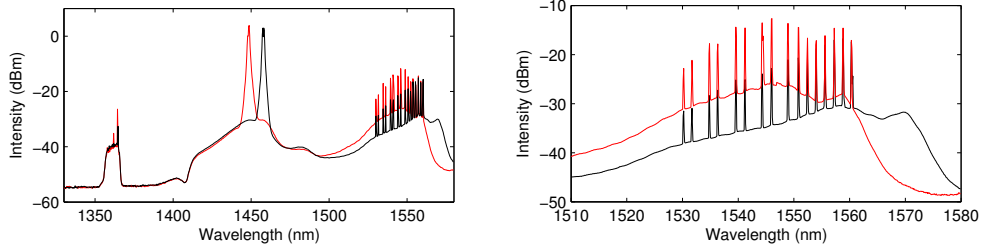

Fig. 2. Comparison of FBGs at 1448nm (red) and 1458nm (black)

The optimal Raman pump power distribution in bidirectional pumping is related to span length. In short links with the kind of relatively small pump powers required for quasi-lossless transmission, symmetrical pumping will offer the best gain distribution across the span with a small power variation [10]. OSNR is highest with forward pumping only, as no amplification of the ASE is present close to the receiver [11]. Pushing the gain into beginning of the span also prevents signal decay. However, care must be taken to balance off the benefits of a higher OSNR with the impairments imposed by Rayleigh scattering and nonlinear effects [7]. In general, and due to the increased fibre loss, long distance unrepeated spans require bi-directional pumping with an optimised forward/backward pump power ratio.

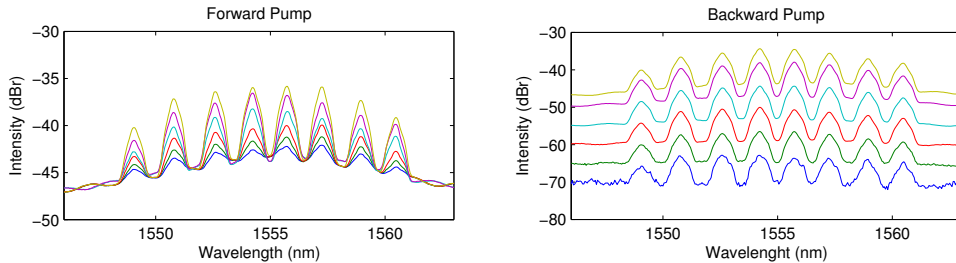

Fig. 3. Forward (left) and Backward (right) pump power optimisation

The experimental results of the influence of different forward and backward pump power ratio on received OSNR and on-off gain measured in 320 km span are shown in Fig. 3. We can notice OSNR improvement with increased forward pump power (left) due to higher gain in the front of the span. Still, backward pumping can reduce overall system loss by pushing gain farther into the span, where the signal intensity is lower. In the figure on the right we can notice on-off gain improvement with increased backward pump power. The maximum output pump power available for each of the two counter-propagating pumps was 2.2 W. The measured optimised pump powers for each transmission length (at the optimal launch signal power) are listed in Table 1.

## 2.2. Experiment results

The received OSNR (0.1 nm resolution bandwidth) and on-off gain were measured experimentally for span lengths from 80 - 360 km, as well as predicted with numerical simulations. The results in Fig. 4 show the best (solid line) and the worst (dashed line) performing WDM channel at different input powers. The URFL-based amplification could fully compensate for the span loss up to 280 km for low input signal powers at 0 dBm, however, distance decreases to 240 km for a total input power of 14 dBm due to pump depletion. As expectable, the best received OSNR was obtained with high input signal powers.

OSNR simulation [4] results for a single channel in the middle of 14 dBm grid at 1550 nm are plotted together with the experimental results for best and worst performing channel in Fig. 5 (left). There is a great agreement between simulation and experimental results.

Table 1. Forward and Backward Raman Pump Powers

D (km)	I/P: 0 dBm		I/P: 5dBm		I/P: 10 dBm		I/P: 14 dBm	
	$P_F$	$P_B$	$P_F$	$P_B$	$P_F$	$P_B$	$P_F$	$P_B$
80	26.4	30.9	26.4	31.1	26.9	31.4	27.2	31.5
120	29.7	31.3	29.8	31.6	29.9	31.9	30.2	32.0
160	30.7	31.8	30.9	32.1	31.1	32.2	31.3	32.3
200	31.8	31.9	31.8	31.9	31.8	31.9	32.0	32.2
240	32.1	32.1	31.9	32.2	31.9	32.4	32.1	32.5
280	32.1	32.4	31.9	32.5	31.9	32.5	32.0	32.5
300	32.1	32.4	31.8	32.5	32.1	32.5	32.2	32.5
320	32.1	32.4	31.9	32.4	32.1	32.4	32.4	32.4
340	32.1	32.4	31.9	32.4	32.0	32.4	32.4	32.4
360	31.0	32.4	31.9	32.4	32.0	32.4	32.2	32.4



Fig. 4. On-off Gain (left) and OSNR (right) measurement results for the best (solid) and the worst (dashed) performing channel. Measured span loss is marked in black.

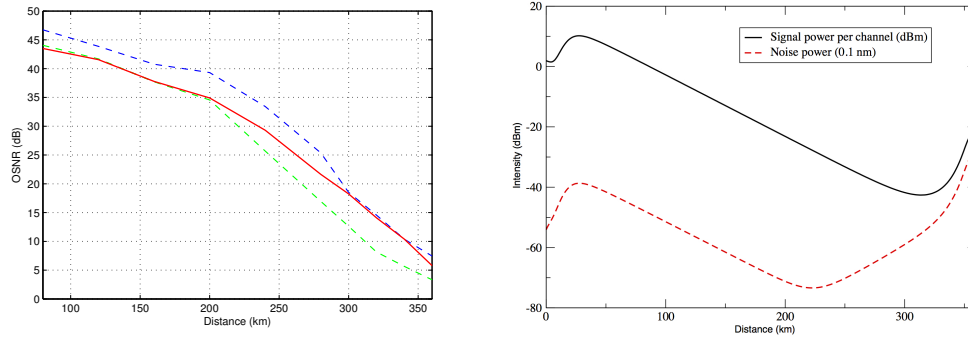

Fig. 5. Simulation results for OSNR (left) measured for a single channel in the middle of the 14 dBm grid at 1550 nm. Dashed lines are experimental results for the best (blue) and worst (green) performing channel. Signal power distribution in 360 km link is shown on the right.

Numerical simulations of the signal power evolution [4] for the 360 km unrepeated link delivering a peak-to-peak signal power excursion of 50 dB and an OSNR of 7.5 dB for a launch power of 2 dBm are presented in Fig. 5 (right). We can see how noise builds up rapidly closer to the fibre end due to the backward pumping amplification. This noise build-up decreases the OSNR to a value below 10 dB, setting a limit for the transmission distance using SMF-28 fibre.

### 3. DPSK transmission

Given the strong OSNR constraints of the system at 360 km, return-to-zero, Differential phase-shift keying (RZ-DPSK) modulation was selected for our transmission experiments. DPSK is an attractive modulation format which can improve receiver's sensitivity by 3 dB compared to amplitude or frequency shift-keying if balanced detection is used [12]. Return-to-zero signalling, on the other hand, can further increase the sensitivity of the receiver [13] as well as enhance the nonlinear threshold and noise tolerance [14]. Below are the obtained results on RZ-DPSK transmission performance in SMF-28 fibre up to 360 km span using URFL based amplification.

#### 3.1. Experiment description

The experimental set-up for transmission BER measurements of RZ-DPSK modulated signal is shown in Fig. 6. To generate the RZ signal, 16 WDM channels are fed into a Lithium niobate Mach-Zehnder modulator driven by a frequency equal to half the data rate. Data is then modulated onto the signal with 42.7 Gb/s  $2^{31} - 1$  pseudorandom bit sequences (PRBS) data pattern by the second Mach-Zehnder modulator.

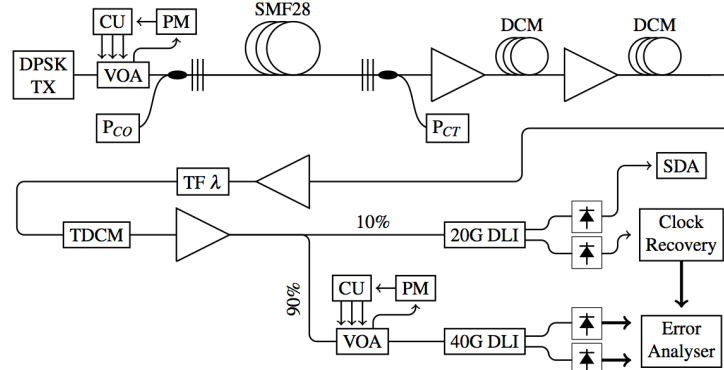

Fig. 6. Experimental setup for 42.7 Gb/s RZ-DPSK transmission with URFL based amplifier. CU: control unit; PM: power meter; P: (CO) forward and (CT) backward-propagating pump; DCM: dispersion compensating module; TF: tuneable filter; TDCM: tuneable dispersion compensating module; DLI: delay line interferometer; SDA: serial data analyser

To compensate for the transmitter loss, the RZ-DPSK signal is amplified by an EDFA and transmitted over the span, which itself uses URFL based amplification. Chromatic dispersion was compensated in a dispersion compensating fibre (DCF) at the receive path. A tuneable filter with 0.4 nm bandwidth was used to demultiplex the WDM channels. To compensate for residual dispersion, a temperature-tuned tuneable dispersion compensation module (TDCM) was deployed after the filter. Balanced detection was used to demodulate RZ-DPSK signal using delay line interferometer (DLI) with a differential delay equal to one bit period and two photodetectors.

#### 3.2. Experiment results

Figure 7 shows an optical spectra of transmitted (blue) and received (red) WDM channels with 200 GHz spacing after 280, 320, 340 and 360 km respectively.

There was no gain flattening filter and no pre-emphasis of channel power used in the experiment. The variation of gain is a result of the single wavelength pump Raman gain curve in silica-core single-mode fibres [15, 16]. Gain degradation in the 1555 nm region seen in Fig. 7 can be shifted by changing the central wavelength of the FBGs reflectors [8]. BER below  $3.8 \times 10^{-3}$  of a 7% hard-decision FEC limit could be achieved for all transmission distances as in Fig. 8.

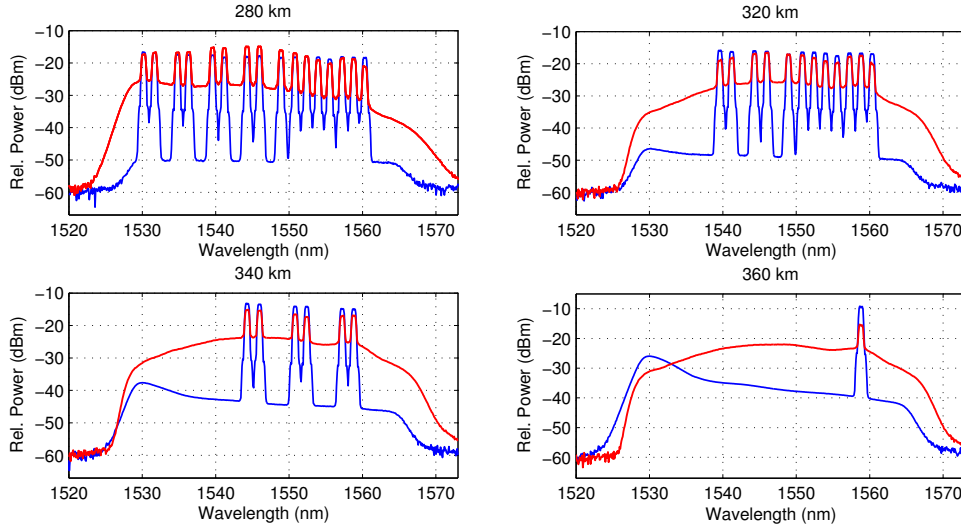

Fig. 7. Transmitted (blue) and received (red) spectra in DPSK transmission

Error free transmission across the full C-band was achieved for 280 km. Transmission at higher distances was limited due to received OSNR and gain bandwidth. The operational bandwidth at 320 km link was 19.2 nm whereas only 6 channels could be transmitted at 340 km and a single channel at 360 km.

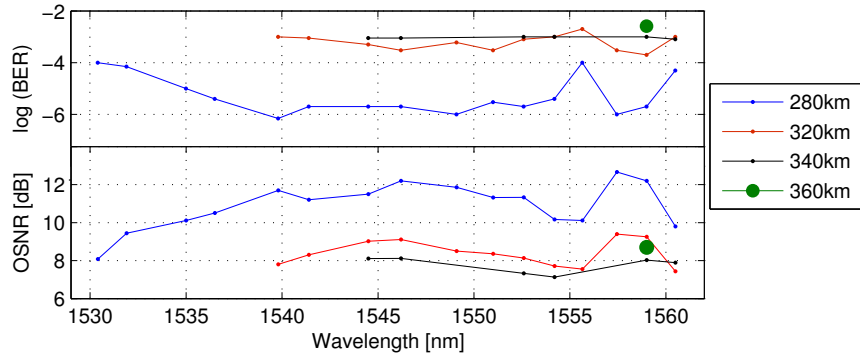

Fig. 8. Experimental results of DPSK unrepeated transmission performance (top) and received OSNR for 280 km, 320 km, 340 km and 360 km.

#### 4. Conclusion

URFL-based amplification has been numerically and experimentally characterised in SMF-28 fibre. The results present excellent noise performance at long distances. Using this configuration, transmission of 42.7 Gb/s RZ-DPSK channels with direct detection up to 360 km has been demonstrated. To our best knowledge, this is the highest distance ever achieved in unrepeated transmission without employing remote pumped doped fibre or speciality fibres. The results confirm that URFL based amplification with a single pump wavelength is highly compatible with currently deployed standard SMF-28 and can be used to upgrade already existing links. A potential improvement of the operational bandwidth could be achieved with multiple sets of FBGs at different wavelengths.

*Acknowledgments:* The authors acknowledge support from the UK EPSRC Programme Grant UNLOC EP/J017582/1 and Spanish MICINN grant RAMAS, TEC2011-27314.